

High Power

SEN Louvre CC 100 Fixture Guide

KKDÖ

Indoor/Outdoor | Surface | Output up to 1155lm/m (352lm/ft)



Key applications

- ✓ Backlighting/Signage
- ✓ Building façades
- ✓ Ceiling
- ✓ Downlighting
- ✓ Flood lighting
- ✓ Interior/Exterior
- ✓ Office lighting
- ✓ Public spaces
- ✓ Wall grazing

Key features

- ✓ Custom lengths
- ✓ Diffusion: Spotting
- ✓ Direct view
- ✓ IP44
- ✓ IP67
- ✓ Lensed

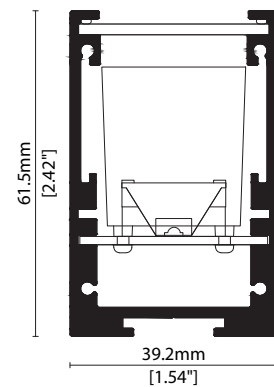

MOUNTING METHODS



KKBK-02 Fixed bracket



KKBK-09 Mounting plate



KKBK-16 Small adjustable bracket



KKBK-17 Large adjustable bracket



KKBK-23 Low adjustable bracket



KKSU-05 Quick release suspension wire kit



SEN Louvre CC 100

Specification sheet



Dimensions	H61.5/W39.2/L210-1810mm (H2.42/W1.54/L8.27-47.64in)
PCB Cut-point	100mm (3.94in)
LED Pitch	100mm - 10LED/m (3.94in - 3LED/ft)
Chip	hcc-line: CREE/Lumileds
Cover/Optics	Clear + 10°/20°/30°
CCT	hcc-line White: 2700K/3000K/3500K/4000K/5000K hcc-line Single colours: Red/Green/Blue
LED binning	hcc-line: 3-step MacAdam Ellipse
CRI	80 (2700K-4000K)/75 (5000K)
Lifetime	50,000 hours @ 25°C (50,000 hours @ 77°F)
Operating temp	350mA: $T_a = -25$ to 75°C ($T_c \text{ max} = 82^\circ\text{C}$) $T_a = -13$ to 167°F ($T_c \text{ max} = 179.6^\circ\text{F}$) 700mA: $T_a = -25$ to 55°C ($T_c \text{ max} = 71^\circ\text{C}$) $T_a = -13$ to 131°F ($T_c \text{ max} = 159.8^\circ\text{F}$)
IP Rating	IP44/67
Finish	Silver anodised
Mounting	Surface mounting via brackets
Power feed	Sheathed hardwire tail
Control	0-10V/1-10V/DMX/DALI via. External power supply options



LED Grading Key

Exclusive Grade

h- hcc-line*	*KKDC tuned CCT range
Constant Current Lensed	
High Power LED	
3-step CCT range	

Power consumption	Supply voltage	Supply current
TYP. 10W/m (3.04W/ft) @ 350mA	TYP. 29V/m (8.83V/ft) @ 350mA	0.35/0.7A/m (0.11/0.21A/ft)
TYP. 21W/m (6.40W/ft) @ 700mA	TYP. 29V/m (8.83V/ft) @ 350mA	

	Clear Cover 10°	Clear Cover 20°	Clear Cover 30°	CRI	R9	Rf	Rg
hcc-line	630lm/m (192lm/ft) 63lm/W @ 3000K, 350mA	630lm/m (192lm/ft) 63lm/W @ 3000K, 350mA	580lm/m (177lm/ft) 58lm/W @ 3000K, 350mA	-	-	-	-
	1155lm/m (352lm/ft) 55lm/W @ 3000K, 700mA	1155lm/m (352lm/ft) 55lm/W @ 3000K, 700mA	1071lm/m (326lm/ft) 51lm/W @ 3000K, 700mA	-	-	-	-

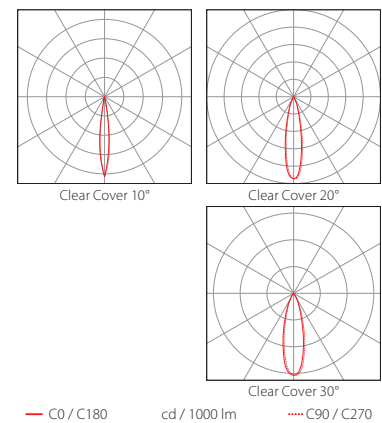
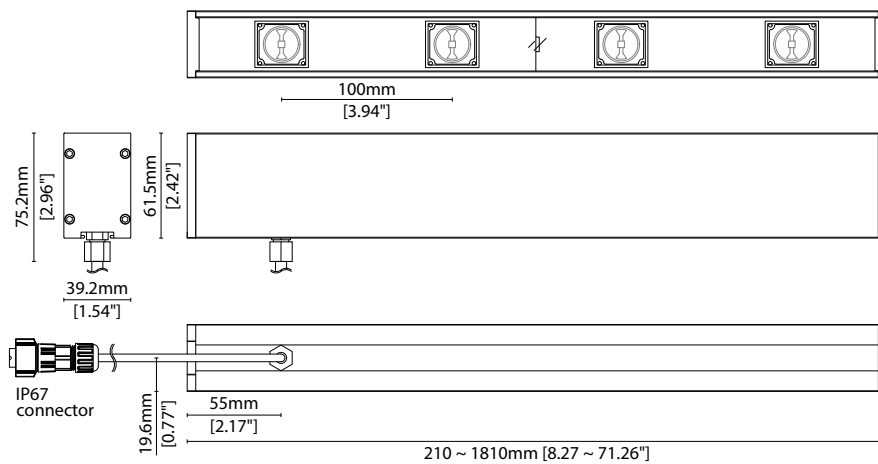

Data derived from independent UKAS/IESNA LM-79-08 accredited testing of production samples.



SEN Louvre CC 100

Code Table



FIXTURE

Model	Finish	Cover	Grade ¹	LED	Colour (CCT)	Length Availability ²	IP	Cable Length	Power Feed ³	Cable Exit ⁴	Lens	Input			
SEN Louvre	SV Silver Anodised	SA Clear B	h	h	100	2700K 27	m 210-1810mm 100mm increments	IP44 44 IP67 ⁵ 67	1000mm /39.37"	1000	Single ø6.3mm sheath tail	S00B	Rear Cable Exit RC	10° 10 20° 20 30° 30	Constant current (DC) a
					3000K 30										
					3500K 35										
					4000K 40										
					5000K 50										
					RED RED										
					GREEN GRN										
					BLUE BLU										
						(Specify length code OR total run length)									
							Double ø6.3mm sheath tail								
							Double ø6.3mm sheath IP67 connector								
							Double ø6.3mm sheath IP67 connector								

¹ Refer to LED Grading Key on Specification sheet page

² Refer to Length Availability List or enter total run length instead of length code

³ Refer to Power Feed Options on Options pages

⁴ Refer to Cable Exit Options on Options pages

⁵ Due to the clear, flush potted polyurethane top layer on IP67 SEN a colour shift of +/-20K should be expected

⁶ Low adjustable bracket needs side cable exit option

Code Example:

SV	-	SA	-	B	-	h	-	100	-	30	-	m	1210	-	67	-	1000	-	S67B	-	RC	-	30	-	a
SEN Louvre		Silver Anodised		Clear		h		100		3000K		m	1210mm		IP67		1000mm/39.37"		Single ø6.3mm sheath IP67 connector		Rear Cable Exit		30°		Constant current (DC)

ACCESSORIES

Mounting Accessories

KKBK-02	Fixed bracket
KKBK-09	Mounting plate
KKBK-16	Small adjustable bracket
KKBK-17	Large adjustable bracket
KKBK-23	Low adjustable bracket
KKSW-05	Quick release suspension kit

* Refer to Mounting accessories on Accessories pages

Exterior Junction Boxes

KKJB-07	IP67 Slim J-Box
KKJB-07R	Potting Resin for IP67 Slim J-Box

* Refer to Exterior Junction Boxes on Accessories pages

PSU/Driver

0-10V/1-10V/DALI/DMX via External power supply options

* Refer to Driver/PSU Options page for details or provide requirement and KKDC to offer the suitable option

LED ENGINE VARIANTS (LED STRIP TYPE)

Colour	LED	Lumen/m	Lumen/ft	W/m	W/ft	Spec Doc	Length	Increment
Single CCT	033	3070	936	69.3	21.12	SEN Louvre CC 033	210-1210mm (8.27-47.64in)	100mm (3.94in)
	050	2107	642	46.2	14.08	SEN Louvre CC 050	210-1210mm (8.27-47.64in)	100mm (3.94in)
	100	1063	362	23.1	7.04	SEN Louvre CC 100	210-1210mm (8.27-47.64in)	100mm (3.94in)

* Performance data: hcc-line, clear glass 10°, 700mA, 3000K

High Power

SEN Louvre CC 100 (350mA) Length Availability List



Length Code		Fixture Length ¹		LED Strip ²		End Cap Dimension ³		Wattage (W)	Output (lm)
Metric	Imperial(US)	Metric	Imperial(US)	Metric	Imperial(US)	Metric	Imperial(US)		3000K (Test Data)
m0210	i0008	210mm	8.27in	200mm	7.87in	10mm	0.39in	1.98	125
m0310	i0012	310mm	12.20in	300mm	11.81in	10mm	0.39in	2.97	187
m0410	i0016	410mm	16.14in	400mm	15.75in	10mm	0.39in	3.96	249
m0510	i0020	510mm	20.08in	500mm	19.69in	10mm	0.39in	4.95	312
m0610	i0024	610mm	24.02in	600mm	23.62in	10mm	0.39in	5.94	374
m0710	i0028	710mm	27.95in	700mm	27.56in	10mm	0.39in	6.93	437
m0810	i0032	810mm	31.89in	800mm	31.50in	10mm	0.39in	7.92	499
m0910	i0036	910mm	35.83in	900mm	35.43in	10mm	0.39in	8.91	561
m1010	i0040	1010mm	39.76in	1000mm	39.37in	10mm	0.39in	9.90	624
m1110	i0044	1110mm	43.70in	1100mm	43.31in	10mm	0.39in	10.89	686
m1210	i0048	1210mm	47.64in	1200mm	47.24in	10mm	0.39in	11.88	748
m1310	i0048	1310mm	51.57in	1300mm	51.18in	10mm	0.39in	12.87	811
m1410	i0048	1410mm	55.51in	1400mm	55.12in	10mm	0.39in	13.86	873
m1510	i0048	1510mm	59.45in	1500mm	59.06in	10mm	0.39in	14.85	936
m1610	i0048	1610mm	63.39in	1600mm	62.99in	10mm	0.39in	15.84	998
m1710	i0048	1710mm	67.32in	1700mm	66.93in	10mm	0.39in	16.83	1060
m1810	i0048	1810mm	71.26in	1800mm	70.87in	10mm	0.39in	17.82	1123

¹ Actual total overall length of light fixture (LED strip + end caps + void/wire hole)

² Actual length of PCB strip

³ Actual length of 2x end caps

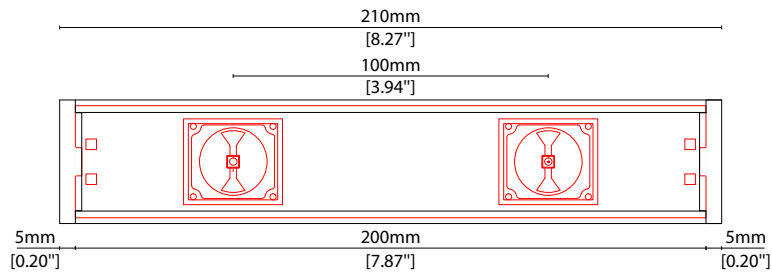

Length Code		Fixture Length ¹		LED Strip ²		End Cap Dimension ³		Wattage (W)	Output (lm) 3000K (Test Data)
Metric	Imperial(US)	Metric	Imperial(US)	Metric	Imperial(US)	Metric	Imperial(US)		
m0210	i0008	210mm	8.27in	200mm	7.87in	10mm	0.39in	4.16	229
m0310	i0012	310mm	12.20in	300mm	11.81in	10mm	0.39in	6.24	343
m0410	i0016	410mm	16.14in	400mm	15.75in	10mm	0.39in	8.32	458
m0510	i0020	510mm	20.08in	500mm	19.69in	10mm	0.39in	10.40	572
m0610	i0024	610mm	24.02in	600mm	23.62in	10mm	0.39in	12.48	686
m0710	i0028	710mm	27.95in	700mm	27.56in	10mm	0.39in	14.56	801
m0810	i0032	810mm	31.89in	800mm	31.50in	10mm	0.39in	16.64	915
m0910	i0036	910mm	35.83in	900mm	35.43in	10mm	0.39in	18.72	1030
m1010	i0040	1010mm	39.76in	1000mm	39.37in	10mm	0.39in	20.80	1144
m1110	i0044	1110mm	43.70in	1100mm	43.31in	10mm	0.39in	22.88	1258
m1210	i0048	1210mm	47.64in	1200mm	47.24in	10mm	0.39in	24.96	1373
m1310	i0048	1310mm	51.57in	1300mm	51.18in	10mm	0.39in	27.04	1487
m1410	i0048	1410mm	55.51in	1400mm	55.12in	10mm	0.39in	29.12	1602
m1510	i0048	1510mm	59.45in	1500mm	59.06in	10mm	0.39in	31.20	1716
m1610	i0048	1610mm	63.39in	1600mm	62.99in	10mm	0.39in	33.28	1830
m1710	i0048	1710mm	67.32in	1700mm	66.93in	10mm	0.39in	35.36	1945
m1810	i0048	1810mm	71.26in	1800mm	70.87in	10mm	0.39in	37.44	2059

¹ Actual total overall length of light fixture (LED strip + end caps + void/wire hole)

² Actual length of PCB strip

³ Actual length of 2x end caps

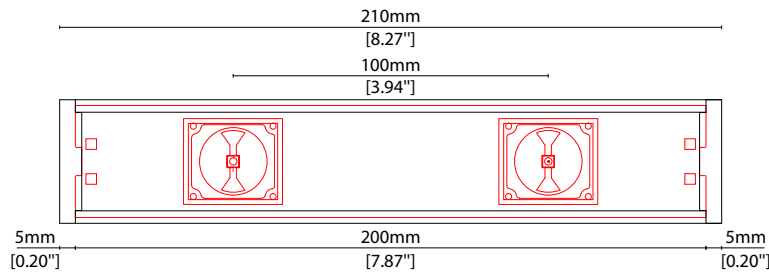



SEN Louvre CC 100 Options



CABLE EXIT OPTIONS

* Options are an integral part of the fixture ordering codes. Please refer to **Code Table** pages.



RC Rear cable exit

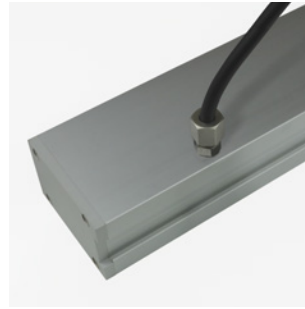
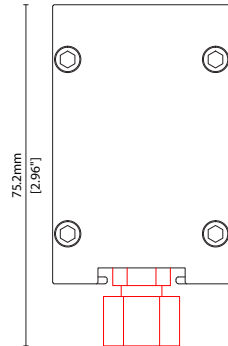

SC Side cable exit

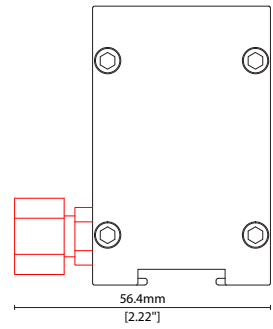

POWER FEED OPTIONS

1000 S00B 1000mm (39.37") Single $\varnothing 6.3$ mm sheath tail

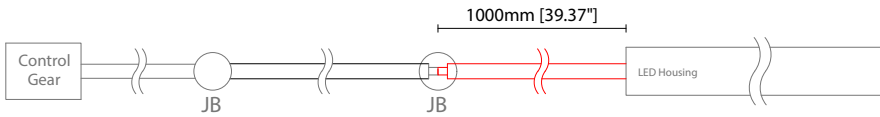

1000 D00B 1000mm (39.37") Double $\varnothing 6.3$ mm sheath tail

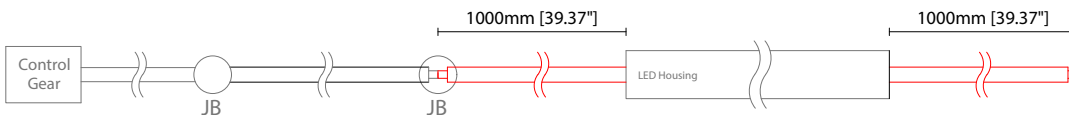

0300 S67B 300mm (11.81") Single $\varnothing 6.3$ mm sheath IP67 connector

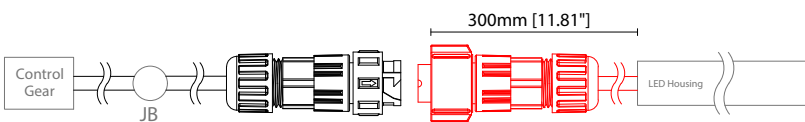

0300 D67B 300mm (11.81") Double $\varnothing 6.3$ mm sheath IP67 connector

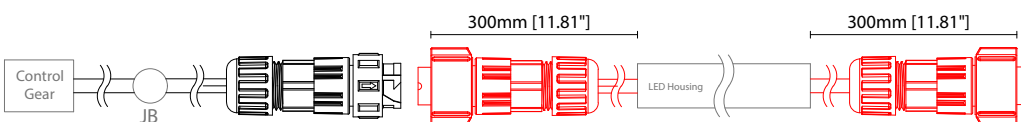

IP67 2 Pin Connector

Female connector
2 PIN (IP67)

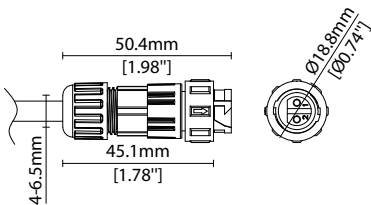

Male connector
2 PIN (IP67)

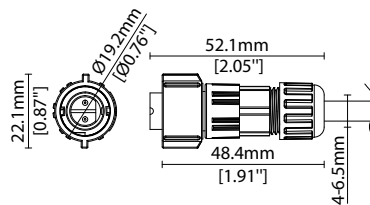

Key

- Control Gear Power supply, sub-controllers & control systems
- JB Junction box / cable connection

High Power

SEN Louvre CC 100 Accessories

KKDÖ

MOUNTING ACCESSORIES

Note: Accessories are to be ordered separately with corresponding code shown below.



KKBK-02

Fixed bracket (allow 2 per metre/40in)
Steel finish
Pre-assembled for double tail

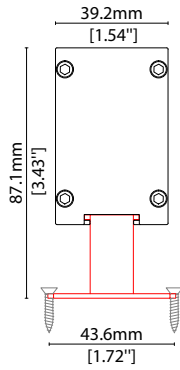

KKBK-09

Mounting plate
(allow 2 per metre/40in – factory fitted)
Silver anodised aluminium finish
Pre-assembled for double tail

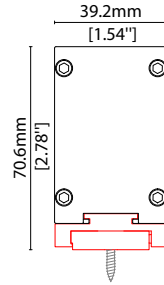

KKBK-23

Low adjustable bracket
(allow 2 per metre/40in)
Silver anodised aluminium finish
Pre-assembled for double tail

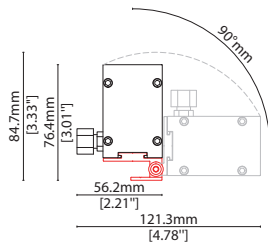

KKBK-16

Small adjustable bracket
(allow 2 per metre/40in)
Silver anodised aluminium finish
Pre-assembled for double tail

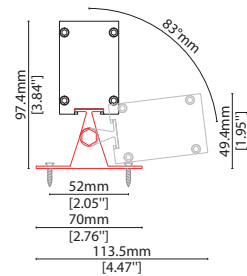

KKBK-17

Large adjustable bracket
(allow 2 per metre/40in)
Silver anodised aluminium finish
Pre-assembled for double tail

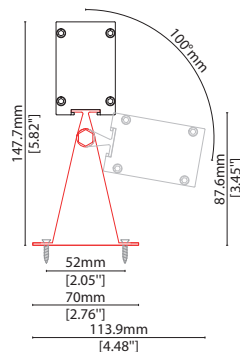

KKSW-05

Quick release suspension wire kit
(1x pair of cables will support up to 2010mm length).

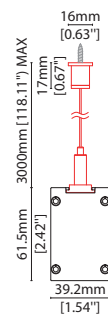



SEN Louvre CC 100 Accessories



EXTERIOR JUNCTION BOXES



KKJB-07

IP67 Slim J-Box
(including type A,B,C,D bushings)



KKJB-07R

Potting resin for IP67 Slim J-Box



SEN Louvre

Driver/PSU Options



AVAILABLE PSU OPTIONS

Control Mode	PSU (Order Code)	Input Voltage AC	Output Voltage DC	Rated Output Current	Rated Power	Dim %	IP Rating
Switched	HLG-60H-C350A	90-305V	100V-200V	0.35A	70W	-	IP65
	HLG-60H-C700A	90-305V	50V-100V	0.7A	70W	-	IP65
	HLG-80H-C350A	90-305V	128V-257V	0.35A	90W	-	IP65
	HLG-80H-C700A	90-305V	64V-129V	0.7A	90W	-	IP65
	HLG-120H-C350A	90-305V	215-430V	0.35A	150W	-	IP65
	HLG-120H-C700A	90-305V	107V-215V	0.7A	150W	-	IP65
	HLG-185H-C700A	90-305V	143V-286V	0.7A	199W	-	IP65
0-10V (1-10V)	HLG-60H-C350B	90-305V	100V-200V	0.35A	70W	-	IP67
	HLG-60H-C700B	90-305V	50V-100V	0.7A	70W	-	IP67
	HLG-80H-C350B	90-305V	128V-257V	0.35A	90W	-	IP67
	HLG-80H-C700B	90-305V	64V-129V	0.7A	90W	-	IP67
	HLG-120H-C350B	90-305V	215-430V	0.35A	150W	-	IP67
	HLG-120H-C700B	90-305V	107V-215V	0.7A	150W	-	IP67
	HLG-185H-C700B	90-305V	143V-286V	0.7A	199W	-	IP67
DMX	POWERdrive 1060/A	120 - 277V	2V-57V	0.35A, 0.7A	100W	-	-
	POWERdrive 106/M	120 - 277V	2V-57V	0.35A, 0.7A	100W	-	-
	POWERdrive 106/S	120 - 277V	2V-57V	0.35A, 0.7A	100W	-	-
	POWERdrive 1061/M	120 - 277V	2V-57V	0.35A, 0.7A	100W	-	-
	POWERdrive 1061/S	120 - 277V	2V-57V	0.35A, 0.7A	100W	-	-
DALI	ELG-100-C350DA	180-295V	143-286V	0.35A	100W	-	IP67
	ELG-100-C700DA	180-295V	71-143V	0.7A	100W	-	IP67
	ELG-150-C700DA	180-295V	150-300V	0.7A	150W	-	IP67